

# Estimation of Tire Cornering Stiffness Using GPS to Improve Model Based Estimation of Vehicle States

Rusty Anderson\* and David M. Bevly†  
Auburn University, 202 Ross Hall Auburn AL 36849

**Abstract—** This paper demonstrates a method of obtaining key vehicle states using GPS and INS measurements with an adaptive model based estimator. A dual antenna GPS attitude system is used to estimate tire cornering stiffness. This estimated parameter is updated in the estimator model to provide more accurate estimates of the vehicle states. The experimental results for the estimate of sideslip and yaw rate using the updated estimator model compare favorable to values predicted by the theoretical model.

## I. INTRODUCTION

A critical component of many modern vehicle control systems, such as stability control and lateral control systems requires the accurate knowledge of vehicle sideslip and yaw rate [1, 2]. The yaw rate, or angular velocity about the vertical axis, can be measured directly with a low-cost gyroscope. However the measurement of sideslip, which is the difference between the velocity vector of the vehicle and the actual heading of the vehicle, requires an expensive speed over ground sensor. Recently, it has been shown that a two antenna GPS attitude system can be used to measure sideslip directly, since it provides both a velocity vector and a true heading [3, 4]. This method, though less expensive than the speed over ground sensor, provides measurements in only the 10-20 Hz range (which is not fast enough for control purposes). Additionally, the GPS measurements may not be available when there is poor visibility of the sky, such as areas of heavy foliage or urban canyons.

Since neither method for measuring sideslip is available on production cars, due to cost, this key vehicle state must be estimated. One of the most common practices to estimate sideslip is by integrating inertial sensors, such as a lateral accelerometer [5, 6]. Another method to estimate sideslip uses inertial sensors with a linear model based estimator [7]. In this estimation scheme, the vehicle's actual parameters are used to estimate the sideslip angle and the yaw rate while using a steer angle as the input into the system and a yaw rate as the measurement state. However, sideslip is unobservable with a yaw rate and steer angle measurement when the vehicle reaches neutral steer characteristics. Other methods for estimating sideslip include use of non-linear observers [8, 9]

A much more recent method of vehicle estimation uses GPS and Inertial Navigation System (INS) sensors [10-12]. One of the most recent methods of estimating sideslip is by

integrating a single GPS antenna with a yaw rate gyroscope [13, 14]. In this method, sideslip is estimated by comparing the vehicle velocity heading provided by GPS with the heading of an integrated yaw gyroscope. Although the kinematic Kalman filter is able to account for the bias present on the gyroscope, the method is unable to account for the presence of a scale factor error on the gyroscope. Recent work has attempted to estimate the gyroscope's scale factor error [15]. Also, with a single antenna receiver, this method can not account for roll or road grade errors which can lead to a false estimation of sideslip. Finally, it has been shown that the kinematic Kalman filter, when used with a dual antenna GPS attitude system, a yaw rate gyro, and accelerometers can be used to estimate sideslip even in the presence of roll or road grade [16]. However, none of the GPS methods of sideslip estimation provides any information to the controller regarding the accuracy of the system model.

One of the newest methods of estimating sideslip is to combine GPS measurements with inertial sensors in a model based estimator [17]. This method provides a direct estimate of sideslip and is robust to gyro scale factor errors but is limited to estimator model accuracy. Another new method of estimating the sideslip is to use a model based estimator and steering torque information on a steer-by-wire vehicle [18]. This method uses a yaw rate gyroscope measurement, steer angle measurement, and a simple observer to estimate the sideslip of a vehicle.

It has been shown that GPS/INS can be used to estimate a vehicle's tire cornering stiffness by using the sideslip estimate to find tire slip angle [19]. These slip angles can be used to solve for the tire cornering stiffness. Other methods proposed for estimating tire cornering stiffness use non-linear observers [20]. This paper investigates the use of estimated tire cornering stiffness using GPS to correct the model of the estimator.

## II. VEHICLE MODEL

The lateral dynamics of the vehicle in the horizontal plane are represented with a single track vehicle, or bicycle model [21] and is shown in Figure 1.

\* anderru@auburn.edu

† dmbevly@eng.auburn.edu

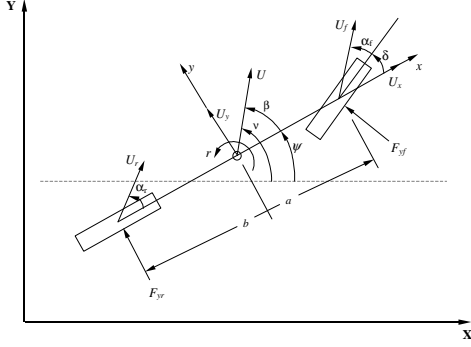

Figure 1. Bicycle Model

The equations of motion for the lateral dynamics of the bicycle model are found by summing the forces and moments around the center of gravity. This leads to the equation of motion for the bicycle model shown below in Equation (1). Note that in Equation (1),  $C_{\alpha f}$  and  $C_{\alpha r}$  are the tire cornering stiffness for the front and rear axle, respectively.

$$\begin{aligned} \sum F_y &= F_{yf} + F_{yr} = m a_y = m(V\dot{\beta} + vr) \\ \sum M_y &= aF_{yf} - bF_{yr} = I_z \dot{r} \end{aligned} \quad (1)$$

Where:

$$\begin{aligned} F_{yf} &= -C_{\alpha f} \alpha_f \approx C_{\alpha f} \left( \beta + \frac{ar}{V} - \delta \right) \\ F_{yr} &= -C_{\alpha r} \alpha_r \approx C_{\alpha r} \left( \beta - \frac{br}{V} \right) \end{aligned}$$

By manipulating Equation (1), the equations for steady state yaw rate and steady state sideslip can be derived and are given in Equation (2). Steady state yaw rate and sideslip are dominated by the weight split and the tire cornering stiffness.

$$\begin{aligned} r_{ss} &= \frac{V}{L + V^2 K_{us}} \delta \\ \beta_{ss} &= \frac{br}{V} - \frac{m_r Vr}{C_{\alpha f}} \\ \text{where } K_{us} &= \frac{W_f}{C_{\alpha f}} - \frac{W_r}{C_{\alpha r}} \end{aligned} \quad (2)$$

### III. VEHICLE ESTIMATION

The GPS measurement of heading can be combined with the yaw rate gyroscope measurement through two types of estimators, a kinematic estimator or a model based estimator. The purpose of combining the GPS measurements with the gyroscope measurements is to provide a high-update rate, unbiased, accurate estimates of the lateral vehicle dynamics.

The discrete Kalman filter for a system represented in Figure 1 consists of two parts: the measurement update and the time update [22]. This step of the Kalman filter only occurs when measurements are available. The equation for the measurement part can be seen in Equation (3).

$$L_k = P_k C_d^T (C_d P_k C_d^T + R_v)^{-1} \quad (3)$$

$$\hat{x}_k = \hat{x}_k + L_k(\gamma)$$

$$P_k = (I - L_k C_d) P_k$$

Where  $L_k$  = Kalman Gain

$P_k$  = Error Covariance Matrix

$C_d$  = discrete Observation Matrix

$R_v$  = Measurement noise matrix

$x_k$  = state estimation

$\gamma$  =  $y - y_{est}$  = residuals

$I$  = Identity Matrix

$k$  = Time Step

The next step of the Kalman filter is the time update, which occurs at every time step, and can be seen in Equation (4).

$$\hat{x}_{k+1} = A_d x_k + B_d u_k \quad (4)$$

$$P_{k+1} = A_d P_k A_d^T + Q_d$$

Where  $A_d$  = discrete State Matrix

$B_d$  = discrete Input Matrix

$u_k$  = input

$Q_d$  = process noise matrix  $\approx B_w Q_c B_w^T T_s$

One of the current ways to combine the GPS heading measurements with the information provided from the yaw gyroscope is through a kinematic or indirect Kalman filter [13]. Additionally, GPS course angle measurements can be combined in a model based estimator. The estimator's state space model is derived from the linearized equations of motion of the bicycle model, seen in Equation (1). The state space equations for the model based estimator are shown in Equation (5).

$$\begin{aligned} \begin{bmatrix} \dot{\beta} \\ \dot{r} \\ \dot{\psi} \\ \dot{b}_{gyro} \end{bmatrix} &= \begin{bmatrix} \frac{-C_{\alpha f} - C_{\alpha r}}{mV} & \frac{-aC_{\alpha f} + bC_{\alpha r}}{mV^2} & -1 & 0 & 0 \\ -aC_{\alpha f} + bC_{\alpha r} & a^2 C_{\alpha f} + b^2 C_{\alpha r} & 0 & 0 & 0 \\ I_z & I_z * V & 0 & 0 & 0 \\ 0 & 1 & 0 & 0 & 0 \\ 0 & 0 & 0 & 0 & 0 \end{bmatrix} \begin{bmatrix} \beta \\ r \\ \psi \\ b_{gyro} \end{bmatrix} + \begin{bmatrix} \frac{C_{\alpha f}}{m * V} \\ \frac{aC_{\alpha f}}{I_z} \\ 0 \\ 0 \end{bmatrix} \delta \end{aligned} \quad (5)$$

$$y = \begin{bmatrix} 0 & 1 & 0 & 1 \\ 1 & 0 & 1 & 0 \end{bmatrix} \begin{bmatrix} \beta \\ r \\ \psi \\ b_{gyro} \end{bmatrix}$$

Additionally the discrete measurement noise covariance and discrete processes noise covariance are shown in Equation (6). Note that the state estimator dynamics will change with  $\sigma_{bias}^2$  [14], but is not a focus of this paper.

$$R = \begin{bmatrix} \sigma_v^2 & 0 \\ 0 & \sigma_r^2 \end{bmatrix} \quad (6)$$

$$Q_d = B_w \begin{bmatrix} \sigma_\delta^2 & 0 \\ 0 & \sigma_{bias}^2 \end{bmatrix} B_w^T T_s$$

where:  $\sigma_{bias}^2 = 1e^{-6}$

This estimator provides a direct estimate of the sideslip ( $\beta$ ), yaw rate ( $r$ ), vehicle heading ( $\psi$ ), and the gyroscope bias ( $b_{gyro}$ ), which again is being modeled as a random walk. The input into this estimator is the steer angle ( $\delta$ ) at the wheel. The two measurements are yaw rate plus the bias (from a gyroscope) and the course angle, heading plus sideslip (from GPS). Vehicle sideslip is not observable using only a yaw rate measurement if the vehicle model is

neutral steer. However, sideslip in this estimator is still observable (when GPS measurements are available) even if the vehicle is neutral steer. Additionally, if the gyroscope measurement is lost, sideslip, yaw rate and heading are still observable with only a GPS course angle measurement. If GPS measurement is lost, then only sideslip (assuming the vehicle model is not neutral steer), yaw rate, and the gyro bias are still observable with only the yaw gyroscope measurements.

Equation (2) shows that steady state yaw rate and sideslip are a function of weight split and tire cornering stiffness. To get the correct steady state sideslip and yaw rate, these are the critical parameters that must be correctly identified. However, trying to estimate all four parameters creates a non-linear estimation problem. Note that weight split can be measured and changes very little with additional loads. By assuming a known weight split, front and rear cornering stiffness ( $C_{af}$  and  $C_{ar}$ , respectively) can be estimated using Equation (7).

$$C_{ar} = \frac{mVr}{\left(\frac{b}{a}+1\right)\alpha_r} \approx \frac{mVr}{\left(\frac{b}{a}+1\right)\left(\beta - \frac{br}{V}\right)} \quad (7)$$

$$C_{af} = \frac{bC_{ar}\alpha_r}{a\alpha_f} \approx \frac{bC_{ar}\left(\beta - \frac{br}{V}\right)}{a\left(\beta + \frac{ar}{V} - \delta\right)}$$

It has been shown that a kinematic Kalman filter can be used to estimate the vehicles sideslip when the gyro scale factor error is removed [13], or by using a two antenna GPS unit [15]. Additionally, it has been shown that tire cornering stiffness can be determined by estimating the vehicle's sideslip (assuming the weight split of the vehicle is known) and solving the linearized bicycle model equations [19]. The estimated tire cornering stiffness can then be used in the model based estimator in order to provide a more accurate model of the vehicle. This new model would allow the model based estimator to provide cleaner state estimates of the vehicle. Additionally, continuous estimation of tire cornering stiffness will compensate for other errors, such as incorrect weight split, because these errors will be incorporated in the estimation of the tire cornering stiffness.

#### IV. SIMULATION

First, a simulation was performed to show the effectiveness of the estimation method. In this simulation the parameters of a 2000 Blazer were used to simulate the vehicle going around a fixed radius turn. The estimator was provided the correct model parameters, with the exception of the front and rear tire cornering stiffness (the tire cornering stiffness were increased by thirty percent). The estimation error results for sideslip and yaw rate from the model based estimator with the incorrect estimator model can be seen in Figure 2. It can be seen in this figure that the slight change of model parameters leads to errors in the state estimation. Note that in this simulation, the only

measurements provided to the estimator are a biased yaw rate gyroscope measurement (with no scale factor error) and the course angle from a single GPS antenna. Additionally, both measurement and process noise was added to the simulation.

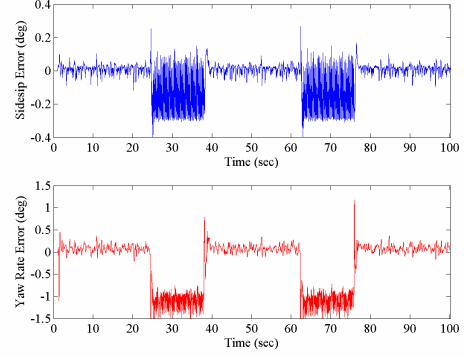

Figure 2. Estimation Error of Incorrect Modeled Vehicle

Next the updated estimator model was used to estimate the sideslip and yaw rate of the vehicle. This sideslip from the dual antenna was then used to calculate the tire cornering stiffness shown in Figure 3 using Equation (7). Note that during straight driving, the tire slip angle is zero so the tire cornering stiffness can not be estimated therefore was set to the original value provided to the estimator.

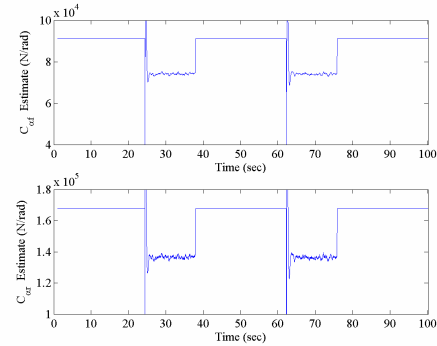

Figure 3. Tire Cornering Stiffness Estimation

The estimates of the tire cornering stiffness for the front and rear wheels are then used in the model based estimator to improve the estimator model accuracy. Figure 4 shows the state estimation of sideslip and yaw rate when the estimated tire cornering is used to modify the estimator model.

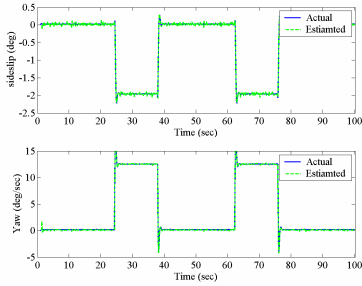

Figure 4. State Estimation Using Updated Model Based Kalman Filter

The estimation error for the sideslip and yaw rate are shown in Figure 5. Notice the difference between the estimation errors when the tire cornering stiffness was not corrected in the estimator model (Figure 2) and when it was corrected by using the updated estimator model (Figure 5).

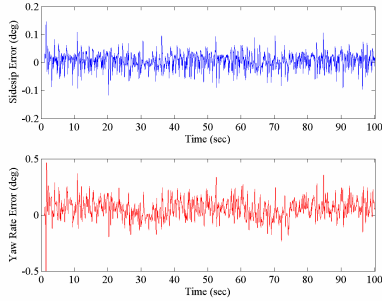

Figure 5. Estimation Error using Updated Estimator Model

The residuals from the model based Kalman filter for the corrected estimator model are shown in Figure 6. It has been shown in previous work that estimator residuals can be used as an indication to the accuracy of the estimator model [18]. Notice the estimator residuals appear mostly random and zero mean, indicating a fairly accurate model is being used in the estimation algorithm. The residuals do have a slight oscillation, which indicates the estimated tire cornering stiffness is slightly inaccurate, due to slight error in the estimated tire cornering stiffness caused by noise on the yaw rate gyroscope measurement and sideslip estimate.

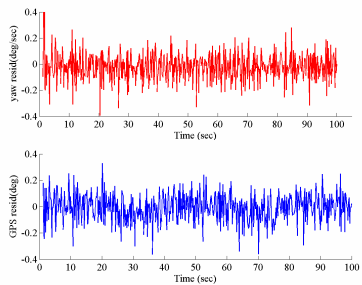

Figure 6. Residuals for Estimator Updated Estimator Model

Next, a simulation was performed to test the estimator method in the presence of other errors, such as an incorrect weight split. In this simulation, the estimator model weight

split (front/rear ratio) was modified from 55/45 to 65/35. Equation (7) is again used to estimate the tire cornering stiffness seen in Figure 7. However in this simulation, the algorithm is unable to estimate the correct tire cornering stiffness values due to the errors in weight split.

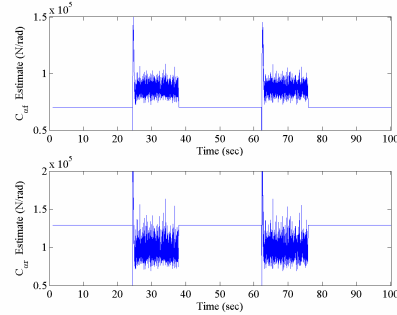

Figure 7. Tire Cornering Stiffness for Incorrect Weight Splits

The estimate of the front and rear wheel tire cornering stiffness is again used in the estimator model. The graphs for the state estimation of sideslip and yaw rate using the updated tire parameters are shown in Figure 8.

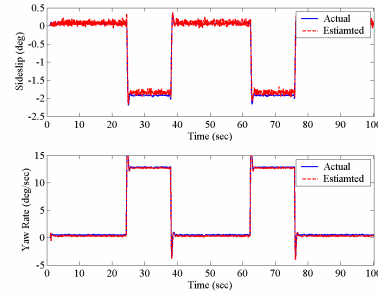

Figure 8. State Estimation using Updated Model Based Kalman Filter

The residuals from the estimator are plotted and are shown in Figure 9. Notice the estimator residuals appear mostly random indicating a more accurate estimator model is being using in the estimation algorithm. Again, the slight oscillation in the residuals is due the estimate of tire cornering stiffness using noisy measurements and estimates.

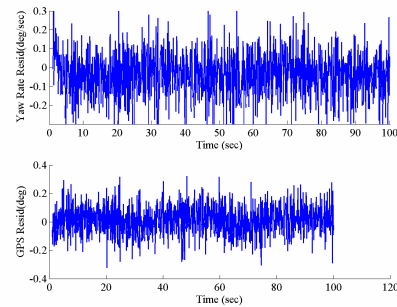

Figure 9. Residuals from the Model Based

## V. EXPERIMENTAL RESULTS

A 2000 Chevrolet Blazer (with known vehicle

parameters) was instrumented for experimental validation of the model based Kalman filter with updated parameters. The Blazer was equipped with a string potentiometer, from Space Age Controls, that measures steer angle at the wheel and is sampled at a rate of 100 Hz. The Blazer was also instrumented with a 6 axis Bosch IMU, consisting of 3 accelerometers and 3 rate gyros, which were also sampled at a rate of 100Hz. Additionally, the Blazer was instrumented with a Starfire GPS receiver, which provided 5 Hz GPS measurements.

An experimental run was taken in a parking lot performing extreme cornering maneuvers. These maneuvers consisted of the vehicle being driven straight for a few seconds and then performing a hard left turn while the velocity is held fairly constant. The measurement update was performed at 5 Hz to coincide with the GPS measurement. The sideslip and yaw rate (actual and estimated) of this run can using the model based estimator be seen in Figure 10. Note that the value for the actual sideslip was calculated post process by comparing the GPS course angle to an integrated yaw rate with scale factor error and bias removed. The estimated value uses the yaw rate and GPS course measurements with no compensation for biases or errors.

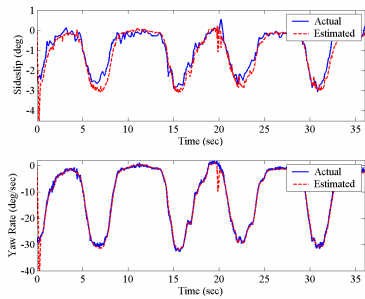

Figure 10. Experimental Results using the Model Based Estimator

As stated previously, the estimator also provides two residuals which can be used to check the model accuracy. The graph of the residuals of the yaw rate and GPS heading are shown in Figure 11.

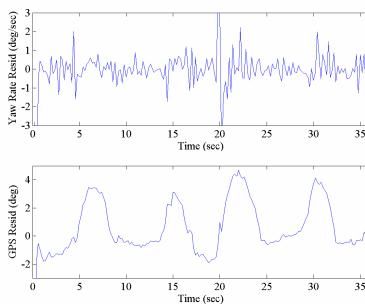

Figure 11. Residuals from the Model Based Estimator

The experimental data was then run through the dual estimators. First, the scale factor error for the yaw rate gyroscope was removed. This allows the sideslip to be

estimated using the kinematic Kalman filter [13, 14]. Then, Equation (7) is used to estimate the tire cornering stiffness shown in Figure 12. Note the repeatability of the cornering stiffness estimates for the four turns.

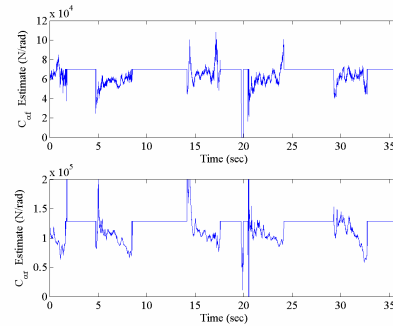

Figure 12. Tire Cornering Stiffness for Extreme Cornering Maneuver

The state estimation results using the estimated tire cornering stiffness values (shown in Figure 12) in the model based estimator can be seen in Figure 13. Note that the estimation of sideslip and yaw rate are much more accurate compared to the same estimation using just the model based estimator and one GPS antenna (which was shown in Figure 10).

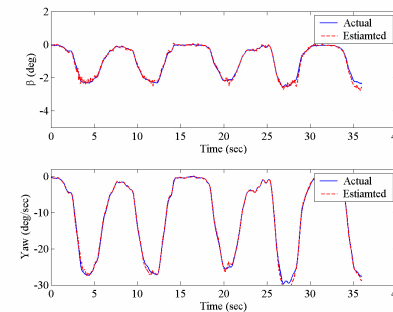

Figure 13. Experimental Results using updated Estimator model

To get some insight on the estimator model accuracy, the residuals from the estimator are plotted in Figure 14. Notice the residuals appear as mostly zero mean white noise (except during the transient dynamics). The yaw rate residual and the GPS residual are closer to theoretical expectations than with the previous (non-adapted estimator model) estimation (Figure 11). This shows the weight split and estimated tire cornering stiffness is fairly accurate while the yaw moment of inertia most likely is incorrect.

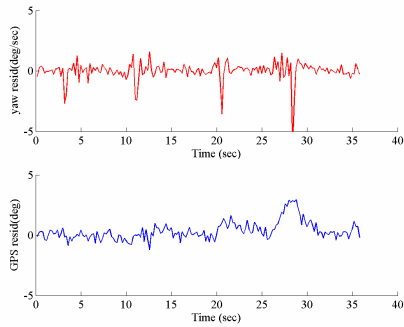

Figure 14. Residuals from Updates Estimator Model

It should be noted that if a dual antenna GPS attitude system is used in place of a single antenna, the kinematic Kalman filter is not necessary to estimate the correct sideslip. Since the attitude system provides a measurement of sideslip, the tire cornering stiffness can be solved using the measurements as was done in the simulation results.

## VI. CONCLUSION

This paper shows the advantages of estimating the important vehicle parameters of tire cornering stiffness and improves the model based Kalman filter. This method was able to correct for errors in the estimator model and provide cleaner more accurate estimates of vehicle sideslip and yaw rate than when just a model based estimator was used to estimate these vehicle states. Additionally, experiments were used to show better estimates of sideslip and yaw rate are yielded by estimating the tire cornering stiffness to correct for estimator model error.

Future work involves identifying new methods of estimating critical vehicle parameters. Non-linear methods should be investigated to try and estimate both weight split and tire cornering stiffness [23]. Additionally, the proposed methods should be tested with a dual antenna GPS receiver, which may provide more robust estimates of the tire cornering stiffness.

## REFERENCES

- [1] Daily, R. Bevly, D. M. "The use of GPS for Vehicle Stability Control System," *IEEE Transactions of Industrial Electronics*, Vol. 51, No. 2, April 2004.
- [2] Nishio H., et. al., "Development of Vehicle Stability Control Based on Vehicle Sideslip Angle Estimations," SAE paper No. 2001-01-0137.
- [3] Cohen, C. E., Parkinson, B.W., McNally, B. D., "Flight Test of Attitude Determination Using GPS Compared Against an Inertial Navigation Unit," *Navigation: Journal of Institute of Navigation*, Vol. 41, No. 1, Spring 2004.
- [4] Hawyard, R., Marchick, A. Powell J. D., "Two Antenna GPS Attitude and Integer Ambiguity Resolution for Aircraft Application," *Proceeding of the ION Technical Meetings*.
- [5] Hac, A., and Simpson, M. "Estimation of Vehicle Sideslip Angle and Yaw Rate," SAE Paper Number 2000-01-0696.
- [6] Kiencke U., Daiss, A., "Observation of Lateral Vehicle Dynamics," *Control Engineering Practice*, Vol. 5., No. 8, August 1997, pp. 1145-1150.
- [7] Farrly, J., Wellstead P., "Estimation of vehicle Lateral Velocity," *Proceedings from the 1996 IEEE conference on Control Application*
- [8] Tseng, H. E., et. al. "Technical Challenges in the Development of Vehicle Stability Control System," *Proceeding from the 1999 IEEE International Control Conference on Control Applications*, Kohala Coast- Island of Hawaii, HI, August 1999..
- [9] Ray, L. "Nonlinear State and Tire Force Estimation for Advanced Vehicle Control," *IEEE transaction on Control System Technology*, 1995, Vol. 3, No. 1, pp. 117-124.
- [10] Hong, S. et. al. "Estimation of Errors in INS with Multiple GPS Antenna," *Proceeding from the 2001 IEEE conference on Industrial Electronic Conference*.
- [11] Berman, Z., Powell, J. D., "The Role of Dead Reckoning and Inertial Sensors in Future General Aviation Navigation," *Proceeding of the 1998 IEEE Position Location and Navigation Symposium*, April 1998, pp. 510-517.
- [12] Ibrahim, F. et. al. "Accurate Gap Filling using Properly Initialized INS During Periods of GPS Signal Blockage," *Proceeding from the 1999 ION-GPS Meetings*,
- [13] Bevly, D. M. et. al. "The Use of GPS Based Velocity Measurements for Improved Vehicle State Estimation," *Proceeding from the ACC 2000*, June 2000, Chicago, IL.
- [14] Bevly, D. M., "GPS: A Low Cost Velocity Sensor for Correcting Inertial Sensor Errors on Ground Vehicles," *Journal of Dynamic Systems, Measurement, and Control*. Vol. 126, No. 2, June 2004.
- [15] Ryu, J. Gerdes, J.C., "Integrating Inertial Sensors with Global Position System for Vehicle Dynamics Control." *Journal of Dynamic Systems, Measurement, and Control*. Vol. 126, No. 2, June 2004
- [16] Ryu, J., Rossetter, E.J., Gerdes, J.C., "Vehicle Sideslip and Roll Parameters Estimation Using GPS," *Proceeding of the AVAC 2002*.
- [17] Anderson, R., Bevly, D.M., "Estimation of Slip Angles using a Model Based Estimator and GPS," *Proceeding from 2004 ACC*.
- [18] Yih, P. Ryu, J., Gerdes, J. C. "Vehicle State Estimation Using Steering Torque," *Proceeding from ACC 2004*.
- [19] Bevly D.M., Sheridan, R., Gerdes, J.C.. "Integrating INS sensors with GPS with GPS Velocity measurements for Continuous Estimation of Vehicle sideslip and Tire Cornering Stiffness," *Proceedings from 2001 ACC*.
- [20] Siemel, W. "Estimation of the Tire Cornering Stiffness and Its Application to Active Car Steering," *Proceeding of the 36<sup>th</sup> Conference on Decision and Control*.
- [21] Milliken, W. F., Milliken, D. L.: *Race Car Vehicle Dynamics*, Society of Automotive Engineers, Inc., Warrendale, PA, 1995.
- [22] Franklin, G., Powell, D., Workman, M.: *Digital Control of Dynamic Systems 3<sup>rd</sup> Edition*, Addison Wesley Longman INC., Menlo Park, CA, 1998.
- [23] Carlson, C., Gerdes, J. C., "Nonlinear Estimation of Longitudinal Tire Slip Under Several Driving Conditions," *Proceeding from 2003 ACC*